

Catálogo de Cirurgia Bucomaxilofacial



**INVESTINDO EM
QUALIDADE
PARA GARANTIR
SEU SUCESSO**





Caros Amigos,

Quando se trata de ambientes cirúrgicos em geral, mais especificamente de procedimentos de Cirurgia Bucomaxilofacial todo contexto está ligado a situações de extrema expectativa por parte do cirurgião , e do paciente, que sempre relaciona o sucesso de uma cirurgia a imagem do cirurgião. Ao cirurgião cabe buscar as melhores ferramentas materiais e humanas para garantir esse sucesso .

Pois bem, sabemos ainda que não existem escalas de importância nesses casos. Uma estrutura bem montada com pessoal qualificado, ambiente seguro e instrumentos de qualidade, transferem ao médico a segurança necessária para representar seu papel da forma esperada por todos.

A melhoria contínua dessa estrutura não é somente uma questão de necessidade, mas também questão de visão de futuro. A Rhosse tem em seu histórico a característica de ser uma empresa moderna e rápida nas decisões.

Em grande parte de nossa trajetória sempre foi primordial investirmos em nossas parcerias, qualificando fornecedores e gerenciando a qualidade dos produtos e serviços que oferecemos. Hoje colhemos frutos de um trabalho sério e voltado para o futuro, que se faz vivo aqui, neste que será o nossa Segunda Edição catálogo de Cirurgia Bucomaxilofacial. Queremos ser seu parceiro

Desde o início nossa preocupação é levar ao mercado produtos de conferida eficiência , aprovados pelas rígidas exigências do mercado e pelos órgãos governamentais que regem nossa atividade. Nossa intenção é que este catálogo possa tornar mais fácil a sua busca por mais qualidade para o seu atendimento a pacientes.

Você pode confiar numa parceria com a Rhosse!

Aproveite nosso catálogo, que ele seja instrumento de ajuda para facilitar sua vida. Confira nossas novidades. Investindo em qualidade para garantir seu sucesso.

CONVERSE COM A GENTE: 0800 7070 667

AUTORIZAÇÃO DE FUNCIONAMENTO

Rhosse Instrumentos e Equipamentos Cirúrgicos Ltda EPP
Autorização nº - U904YW4L815M
A.R. Indústria e Comércio de Instrumentos Cirúrgicos Ltda - ME
Autorização nº - G141WW6M88XW

REGISTRO NO MINISTERIO DA SAÚDE

Instrumentos Cirúrgicos Não Articulados Cortantes Rhosse	MS 80310620001
Instrumentos Cirúrgicos Articulados Cortantes Rhosse	MS 80310620002
Instrumentos Cirúrgicos Articulados Não Cortantes Rhosse	MS 80310620003
Instrumentos Cirúrgicos Não Articulados Não Cortantes Rhosse	MS 80310620004

REGISTRO NO FDA - FOOD AND DRUG ADMINISTRATION

Operator Number	10029069
-----------------	----------



Íris - Ponta Fina

CURVA. 11 CM RH01001
RETA. 11 CM RH01002



Íris - Ponta Romba

CURVA. 11 CM RH01003
RETA. 11 CM RH01004



Íris com Faceta - Ponta Fina

CURVA. 11 CM RH01006
RETA. 11 CM RH01005



Íris com Faceta Serrilhada Ponta Fina

CURVA. 11 CM RH11913
CURVA. 14 CM RH01025
RETA. 11 CM RH11914
RETA. 14 CM RH01024



Stevens - Ponta Fina

CURVA. 09 CM RH13051
CURVA. 11 CM RH01008
CURVA. 14 CM RH01012
CURVA. 16 CM RH10576
CURVA. 18 CM RH11209
RETA. 09 CM RH12929
RETA. 11 CM RH01007
RETA. 14 CM RH01011
RETA. 16 CM RH11000
RETA. 18 CM RH11331

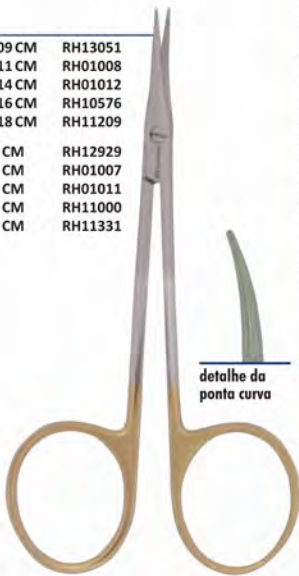

Stevens - Ponta Romba

CURVA. 11 CM RH01010
CURVA. 14 CM RH01014
CURVA. 16 CM RH11328
CURVA. 18 CM RH11329
RETA. 11 CM RH01009
RETA. 14 CM RH01013
RETA. 16 CM RH10999
RETA. 18 CM RH11330

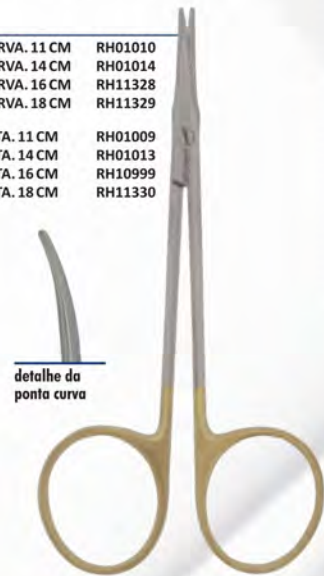

Reynolds

CURVA. 11 CM RH12790
CURVA. 15 CM RH11477
CURVA. 18 CM RH11476



Goldman Fox

CURVA. 11 CM RH12506
CURVA. 14 CM RH12272
RETA. 11 CM RH12509
RETA. 14 CM RH12082

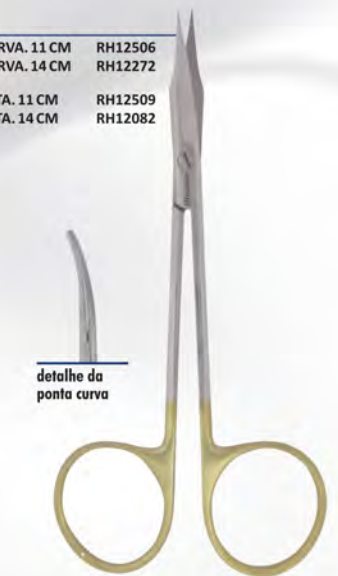

Lagrange

11 CM RH01019



Converse

11 CM RH01017
15 CM RH01018



Fomon

11 CM RH01015
14 CM RH01016
18 CM RH01066
20 CM RH10249
25 CM RH11741



Kilner

11 CM RH01020
14 CM RH01021





Joseph

CURVA. 14 CM RH01060
 RETA. 14 CM RH01059



detalhe da
 ponta curva

Standard | Cirúrgica

CURVA. 15 CM RH12518
 CURVA. 17 CM RH12655

RETA. 15 CM RH12516
 RETA. 17 CM RH10268



detalhe da
 ponta curva

Snolden - Serrilhada

CURVA. 15 CM RH01038
 CURVA. 17 CM RH01040

RETA. 15 CM RH01037
 RETA. 17 CM RH01039



detalhe da
 ponta curva

Mayo

CURVA. 15 CM RH01032
 CURVA. 17 CM RH01034
 CURVA. 19 CM RH01036
 CURVA. 22 CM RH01068

RETA. 15 CM RH01031
 RETA. 17 CM RH01033
 RETA. 19 CM RH01035
 RETA. 22 CM RH01069



detalhe da
 ponta curva

Metzenbaum

CURVA. 14 CM RH01027
 CURVA. 16 CM RH11406
 CURVA. 18 CM RH01029
 CURVA. 20 CM RH10280
 CURVA. 22 CM RH01030

RETA. 14 CM RH01026
 RETA. 16 CM RH10632
 RETA. 18 CM RH01028
 RETA. 20 CM RH10284
 RETA. 22 CM RH10428

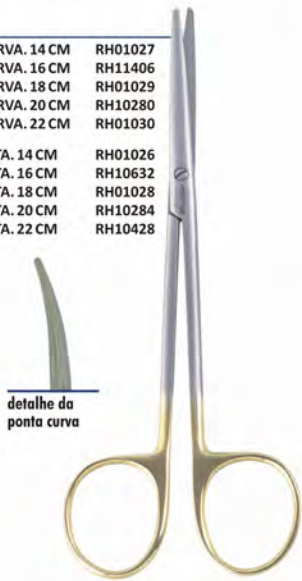

detalhe da
 ponta curva

Boyd

14 CM RH10705
 19 CM RH01063



detalhe da
 lateral

Spencer

CURVA. 09 CM RH12076
 CURVA. 11 CM RH11572

RETA. 09 CM RH11570
 RETA. 11 CM RH01022



detalhe da
 ponta curva

Bifacetada - Serrilhada

CURVA. 14 CM RH01043
 CURVA. 18 CM RH01044
 CURVA. 21 CM RH01045



detalhe da
 ponta curva

Fio de Aço - Angulada

11 CM RH01064



Pelicano - Serrilhada

17 CM RH01051



Aston - Serrilhada

RETA. 18 CM RH01046
 RETA. 21 CM RH01047



detalhe da
 ponta

Mc Indoe - Serrilhada

CURVA. 18 CM RH01048
 CURVA. 21 CM RH01049



detalhe da
 ponta



Cotle - Serrilhada

14 CM RH01054
15 CM RH01055
16 CM RH01056



Heyman - Serrilhada

18 CM RH01052



Bico de Pato

CURVA. 20 CM RH14071



Rees

19 CM RH01050



Hemostáticas | Hemostatics | Hemostáticas

Mosquito (Halstead)

CURVA. 09 CM RH01502
CURVA. 12 CM RH01504
CURVA. 18 CM RH10452
CURVA. 21 CM RH10933
RETA. 09 CM RH01501
RETA. 12 CM RH01503
RETA. 18 CM RH10932
RETA. 21 CM RH10654



Kelly

CURVA. 14 CM RH01520
CURVA. 16 CM RH01521
CURVA. 18 CM RH10670
RETA. 14 CM RH01518
RETA. 16 CM RH01519
RETA. 18 CM RH10670



Mixer

12 CM RH01522
14 CM RH01523
16 CM RH01524
18 CM RH01525
20 CM RH01526



Kocher

CURVA. 12 CM RH12859
CURVA. 14 CM RH01515
CURVA. 16 CM RH01516
CURVA. 18 CM RH01517
CURVA. 20 CM RH10935
CURVA. 24 CM RH10937
RETA. 12 CM RH12858
RETA. 14 CM RH01512
RETA. 16 CM RH01513
RETA. 18 CM RH01514
RETA. 20 CM RH10449
RETA. 24 CM RH10941



Backaus

08 CM RH01505
10 CM RH01506
13 CM RH01507



Allis

CURVA. 18 CM RH11785
CURVA. 20 CM RH10150
RETA. 12 CM RH10624
RETA. 15 CM RH01508
RETA. 18 CM RH01509
RETA. 20 CM RH10665



Collin - Oval

18 CM RH12144



Pean

14 CM RH01510
16 CM RH01511





Hartman

15 CM RH11764
19 CM RH11764



Kocher Angulada - 90°

20 CM RH13689



Bruenings para Septo

N.º 0. 19 CM RH13735
N.º 1. 19 CM RH13736
N.º 2. 19 CM RH13737



Rochester Pean

CURVA. 16CM RH10966
CURVA. 18 CM RH10967
CURVA. 20 CM RH10558
CURVA. 22 CM RH10968
CURVA. 24 CM RH10969
CURVA. 26 CM RH10970
CURVA. 30 CM RH10971

RETA. 16CM RH10962
RETA. 18 CM RH10963
RETA. 20 CM RH10667
RETA. 22 CM RH10964
RETA. 24 CM RH10965
RETA. 26 CM RH10973
RETA. 30 CM RH10974



Rochester Lateral

20 CM RH13715



Scoobe Allis

20 CM RH17179



Porte Exerto - Fenestrada

16 CM RH13697



Porta Exerto - 3 Furos

16 CM RH13698



**Backaus de Redução - 13 cm
Cremalheira e Bolinha**

RH13059



**Backaus de Redução - 13 cm
com Guia (Tubinho)**

CURVA RH15076
RETA RH13846

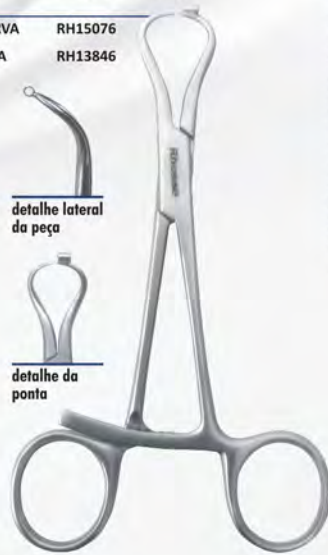

**Backaus de Redução - 13 cm
Cremalheira**

RH10463



Especímetro Ósseo

13 CM RH13753





Mayo Hegar com Vídea

- | | |
|-------|---------|
| 12 CM | RH01202 |
| 14 CM | RH01203 |
| 16 CM | RH01204 |
| 18 CM | RH01205 |
| 20 CM | RH01206 |
| 22 CM | RH10193 |
| 25 CM | RH10180 |
| 30 CM | RH10443 |



Mayo Hegar sem Vídea

- | | |
|-------|---------|
| 12 CM | RH12792 |
| 14 CM | RH01229 |
| 16 CM | RH01230 |
| 18 CM | RH01231 |
| 20 CM | RH01232 |
| 22 CM | RH15518 |
| 25 CM | RH12034 |
| 30 CM | RH12465 |



Mayo Hegar sem Vídea Liso

- | | |
|----------------|---------|
| FIO 6,0. 12 CM | RH01201 |
| FIO 6,0. 14 CM | RH12791 |



Mayo Hegar com Vídea Delicado

- | | |
|-------|---------|
| 14 CM | RH12925 |
|-------|---------|



Porta Agulha Tesoura Olsen Hegar

- | | |
|-------|---------|
| 12 CM | RH15039 |
| 14 CM | RH15040 |
| 16 CM | RH15041 |



Ryder com Vídea

- | | |
|-------|---------|
| 12 CM | RH01207 |
| 14 CM | RH01208 |
| 16 CM | RH01209 |
| 18 CM | RH01210 |
| 20 CM | RH01211 |
| 22 CM | RH10704 |
| 25 CM | RH01233 |

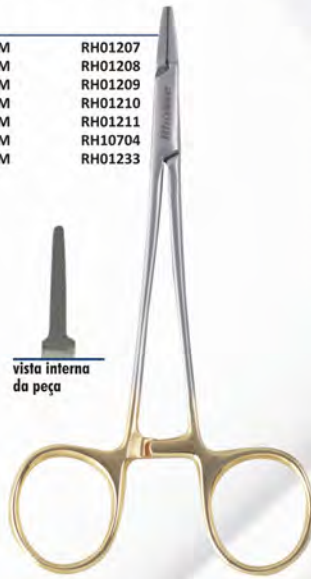

Fio de Aço com Vídea

- | | |
|-------|---------|
| 16 CM | RH01226 |
| 18 CM | RH01227 |



Derf com Vídea

- | | |
|-------|---------|
| 12 CM | RH01202 |
|-------|---------|



Stratte

- | | |
|-------|---------|
| 19 CM | RH13152 |
| 23 CM | RH13153 |



Mayo Hegar Angulado com Vídea Mayo Hegar Curvo com Vídea

- | | |
|-----------------|---------|
| CABO 45°. 18 CM | RH13947 |
|-----------------|---------|



- | | |
|-------|---------|
| 12 CM | RH15037 |
| 14 CM | RH15038 |
| 16 CM | RH15027 |





Adson - Serrilhada

12 CM RH01104
15 CM RH01105
18 CM RH01106



detalhe da ponta



Adson - Brown

12 CM RH01107
15 CM RH01108
18 CM RH01109



detalhe da ponta



Adson - Dente e Sapata

12 CM RH10061
15 CM RH10062
18 CM RH10063



detalhe da ponta



Adson - Micro Dente de Rato

12 CM RH13901



detalhe da ponta



Adson com Vídea e Dente

12 CM RH12993
15 CM RH12994
18 CM RH12995



detalhe da ponta



Adson - Dente de Rato

12 CM RH01101
15 CM RH01102
18 CM RH01103



detalhe da ponta



Adson com Vídea

13 CM RH13204
15 CM RH13955
18 CM RH15317



detalhe da ponta



Adson - Micro Serrilhada

12 CM RH14074



detalhe da ponta



Adson - Gancho e Vídea

12 CM RH15415



detalhe da ponta



detalhe da ponta



Adson - Gancho

12 CM RH15414



detalhe da ponta



detalhe da ponta



Adson - Dietrich

12 CM RH12996
15 CM RH13004
18 CM RH13005



detalhe da ponta



Dietrich - Atraumática Delicada

16 CM RH10075
18 CM RH10698
20 CM RH11730
22 CM RH11829
25 CM RH10591



detalhe da ponta





Cushing - Reta

SERRILHADA
18 CM RH10546
COM DENTE
18 CM RH10547



Cushing - Curva

SERRILHADA
18 CM RH12997
COM DENTE
18 CM RH12999



Retirada de Pontos

09 CM RH10495
12 CM RH01110



Baioneta

14 CM RH01114
16 CM RH00115



Anatômica com Vídea

12 CM RH13022
14 CM RH12922
16 CM RH01118
18 CM RH01119
20 CM RH01120



Anatômica - Serrilhada

10 CM RH10072
12 CM RH10402
14 CM RH10520
16 CM RH10401
18 CM RH10403
20 CM RH10404



Anatômica com Dente

12 CM RH13901



Sutura de Cartilagem

RH10082



Pinça Clínica para Algodão



Columela

RH11323



Calázio Aberta

GRANDE RH13954
MÉDIA RH13953
PEQUENA RH13952



Calázio Fechada

GRANDE RH11904
MÉDIA RH11903
PEQUENA RH11902





Tesoura Castroviejo - Curva Goldman Fox

CURVA. 13 CM RH01058
CURVA. 15 CM RH13141

RETA. 13 CM RH01057
RETA. 15 CM RH13272



Tesoura Vannas

CURVA. 09 CM RH10442

RETA. 09 CM RH10706



Tesoura Castroviejo Potts

09 CM RH10707
13 CM RH10286



Porta Agulha Castroviejo sem Videa

CURVO. 13 CM RH01213
CURVO. 15 CM RH11569
CURVO. 18 CM RH13143

RETO. 13 CM RH01213
RETO. 15 CM RH11569
RETO. 18 CM RH13143

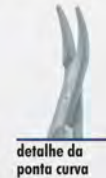

Tesoura Castroviejo - Curva Série Especial

13 CM RH12387

Fios: 8, 9 e 10



Tesoura Castroviejo - Reta Série Especial

13 CM RH12688

Fios: 8, 9 e 10



Porta Agulha Castroviejo - Curvo Série Especial

13 CM RH12388

Fios: 8, 9 e 10



Porta Agulha Castroviejo - Reto Série Especial

13 CM RH12770

Fios: 8, 9 e 10



Microcirurgia - Reta

12 CM RH01117
15 CM RH11611
18 CM RH11608



Microcirurgia - Curva

12 CM RH01122
15 CM RH11610
18 CM RH11607



Microcirurgia - Angulada

12 CM RH01121
15 CM RH11609
18 CM RH11606



Microcirurgia com Dente

12 CM RH01116
15 CM RH12245
18 CM RH13134





Cureta para Seio Maxilar - Jogo com 10 Curetas

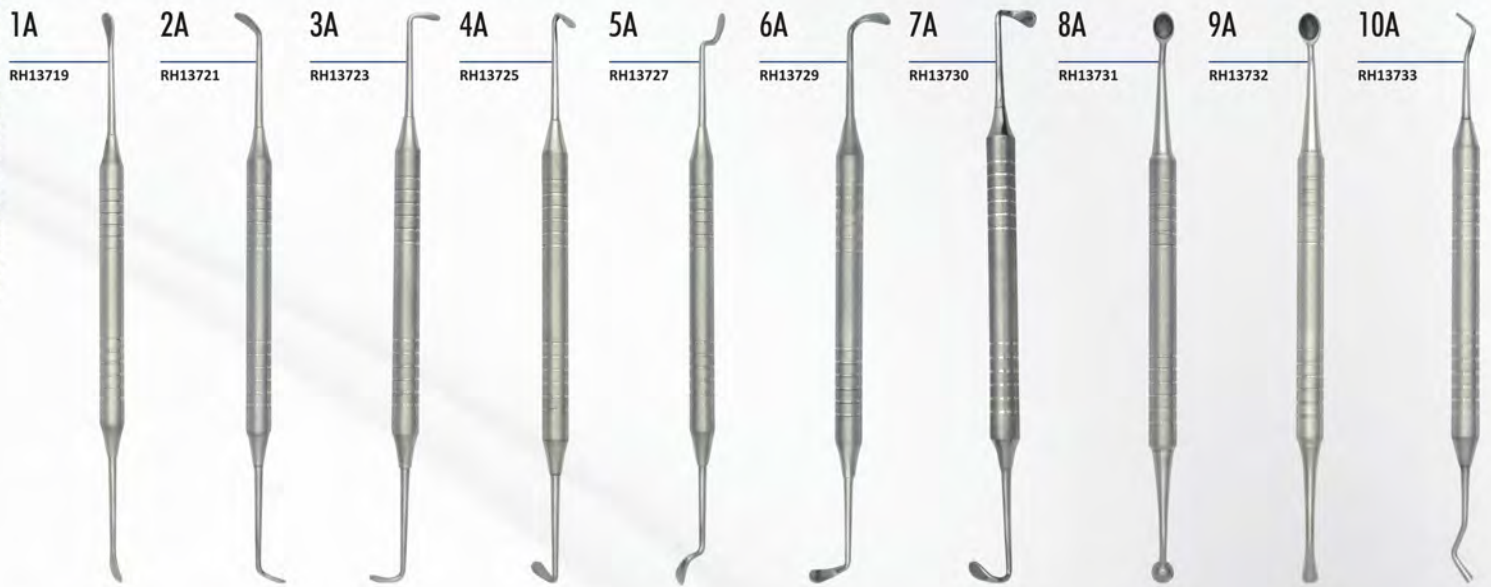

Cureta para Seio Maxilar - Jogo com 06 Curetas

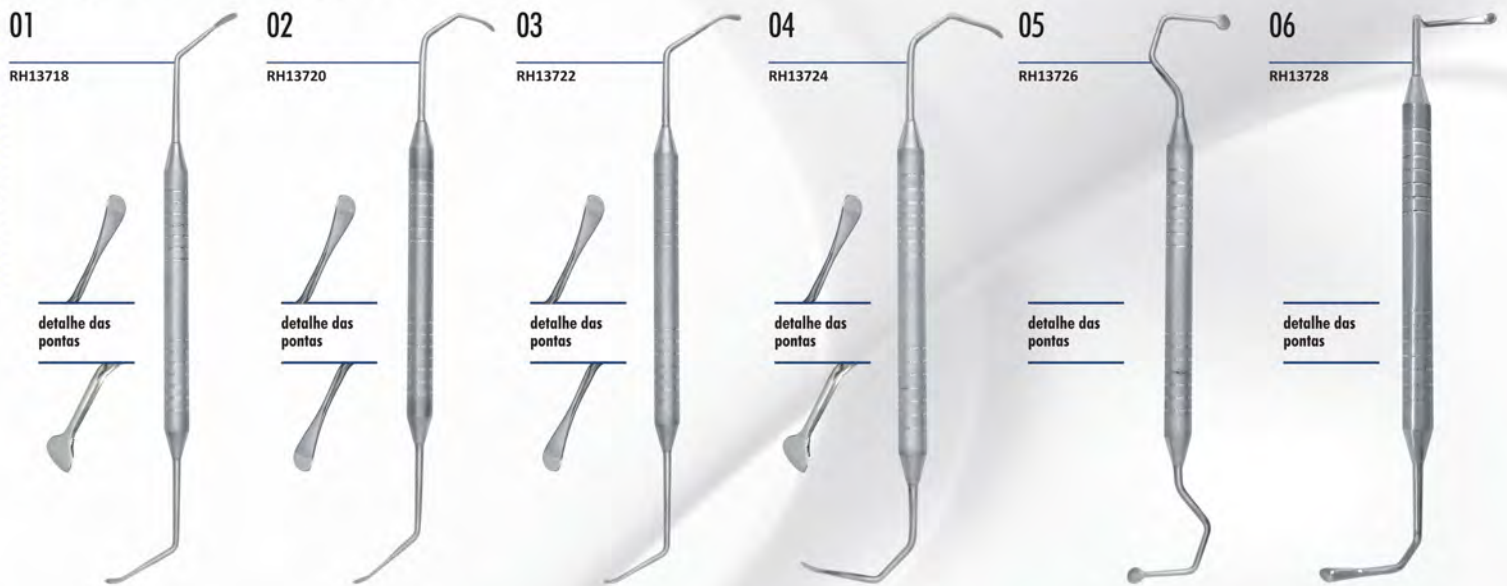

Descolador Prichard 3

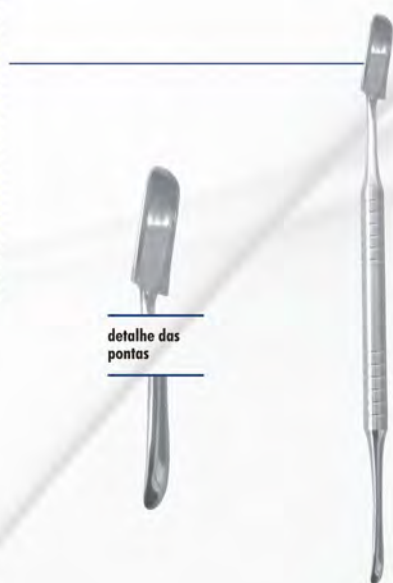

Cureta de Lucas

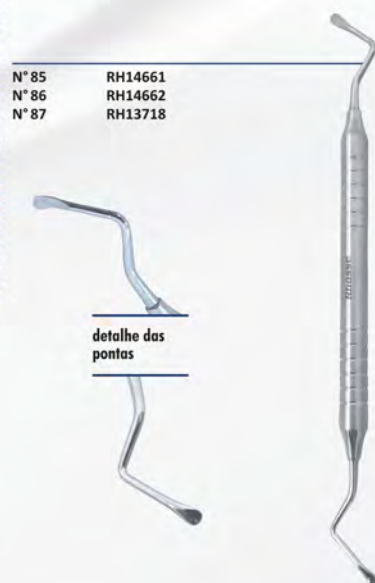

Raspa Puncionada para Osso - 20 cm

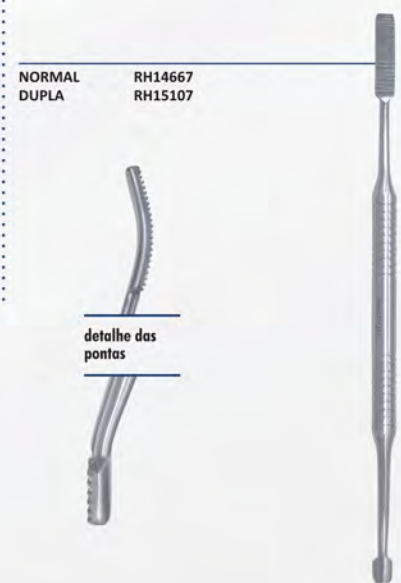



Freer - Nóbrega

RH10046

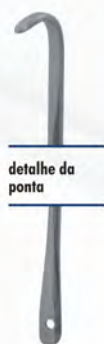

detalhe da
ponta



Freer - Duplo

RH01601

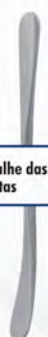

detalhe das
pontas



Freer - Conrtante

RH01602

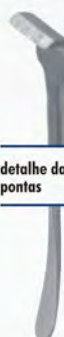

detalhe das
pontas



Freer - Triangular

RH10603

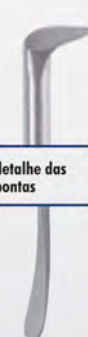

detalhe das
pontas



Freer - Veau

RH01604



detalhe das
pontas



Freer - Modificado

RH13691

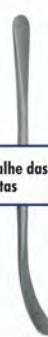

detalhe das
pontas



Hurd

23 CM

RH10766

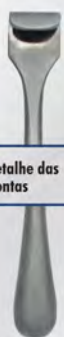

detalhe das
pontas



Molt 2/4 - Cureta

RH13299

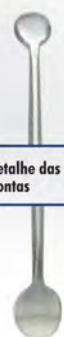

detalhe das
pontas



Molt

RH10048

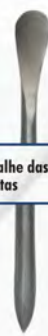

detalhe das
pontas



Seldin

RH13714

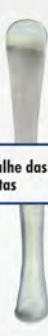

detalhe das
pontas



Rugina Farabeuf

CURVA. 14 CM

RH10525

RETA. 14 CM

RH10556



detalhe da ponta
reta



Rugina Lambotte

15 CM

RH10988

20 CM

RH12839





Reto - 19 cm

04 MM	RH01401
06 MM	RH01402
08 MM	RH01403
10 MM	RH01404
12 MM	RH01405
14 MM	RH01406
16 MM	RH01451



Curvo - 19 cm

04 MM	RH01407
06 MM	RH01408
08 MM	RH01409
10 MM	RH01410
12 MM	RH01411
14 MM	RH01412
16 MM	RH01452



De Fratura

02 MM	RH01413
03 MM	RH01414
04 MM	RH01415



1 Guia - Reto

06 MM	RH01416
08 MM	RH01417
10 MM	RH01418



Silver - Reto

06 MM	RH01428
08 MM	RH01425



1 Guia - Curvo (Par)

06 MM	RH01419
08 MM	RH01420
10 MM	RH01421



Em V para Septo Reto

RH01427



2 Guias - Reto

10 MM	RH01422
12 MM	RH01423
14 MM	RH01424



Silver - Curvo (Par)

06 MM	RH01429
08 MM	RH01426





Cinzel de Wagner
Angulado

06 MM RH13018
08 MM RH13021



detalhe da
ponta forte

Cinzel de Wagner
Curvo

06 MM RH13016
08 MM RH13019



Cinzel de Wagner
Reto

06 MM RH13017
08 MM RH13020



Cinzel de Sverzut

RH12650



Cinzel de Lucas - Goivo
Angulado

RH12757



Cinzel de Lucas - Goivo
Reto

RH13150



Cinzel de Lucas - Bixel
Reto

03 MM RH13193
04 MM RH13194



Martelo

100 G RH10469
150 G RH12921
250 G RH01450
500 G RH10470
750 G RH10653



Martelo de Mead
com batente de Fibra

PEQUENO RH13748
GRANDE RH13749





Guilles - 17 cm

DELICADO RH01301
FORTE RH01302



Joseph - 17 cm

DELICADO RH01303
FORTE RH01304



Guthrie 2 Garras - 17 cm

AGUDO RH11336
ROMBO RH11335



2 Garras - 17 cm

AGUDO RH10607
ROMBO RH10532



3 Garras - 17 cm

AGUDO RH10608
ROMBO RH10533



4 Garras - 17 cm

AGUDO RH10609
ROMBO RH10534



Duplo Agudo - 17 cm

06 MM RH01307
08 MM RH01308
10 MM RH01309
12 MM RH01310
14 MM RH01311

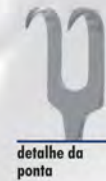

Duplo Rombo - 17 cm

06 MM RH01312
08 MM RH01313
10 MM RH01314
12 MM RH01315
14 MM RH01316



Gilles Duplo em V - 17 cm

RH01319



Tipo Compasso - 11 cm

RH10414



Fomon - Bolinha

RH10146



Malar de Barros

RH01320



Malar com Cabo

RH01320





Apical

JOGO COM 03 PÇS RH12759
 DIREITA RH14843
 ESQUERDA RH14844
 RETA RH14845



Heidbrink

JOGO COM 03 PÇS RH13125
 ESQUERDA. Nº 1 RH11532
 RETA. Nº 2 RH11533
 DIREITA. Nº 3 RH11534



Seldin

JOGO COM 03 PÇS RH11820
 DIREITA. 1 R RH11529
 ESQUERDA. 1 L RH11530
 RETA RH11535



Apexo

PARA CIMA RH12972
 PARA BAIXO RH12973



Descolador Smith

RH13752



Psilakis para Ramo

RH11560



Psilakis

RH010607



Periósteo

04 MM RH01605
 07 MM RH01606



Alexander

Bizel

03 MM RH13200
 04 MM RH13199

Goiva

03 MM RH13197
 04 MM RH13198

Formão

03 MM RH13202
 04 MM RH13201





Sperli Dorso - Nº 1, 2 e 3

- Nº 1. DELICADA RH01430
- Nº 2. MÉDIA RH01431
- Nº 3. GROSSA RH01432

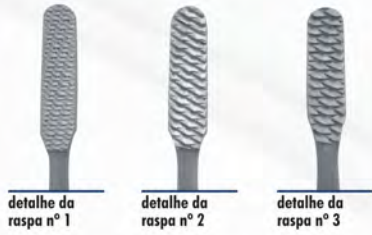

Sperli Glabela - Nº 1, 2 e 3

- Nº 1. DELICADA RH01433
- Nº 2. MÉDIA RH01434
- Nº 3. GROSSA RH01435

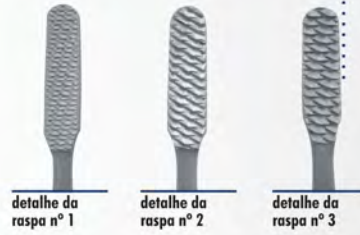

Sperli Dorso - Dupla Delicada e Média

- Nº 1 e Nº 2 RH01436

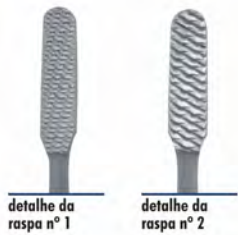

Sperli Dorso - Média com Vídea

- Nº 2. MÉDIA RH10421



Diamantada

- RH12511



Alavanca Potts - Par

- RH14655

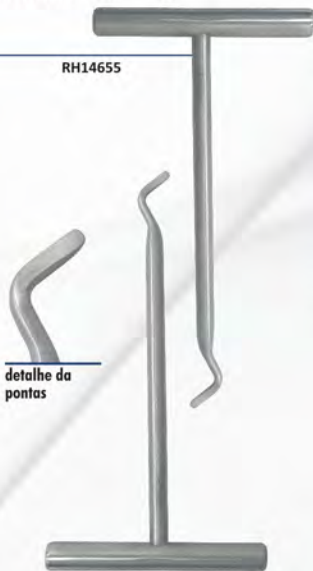

Raspador Ósseo

- 05 MM RH13750
- 07 MM RH13751



Esmagador de Cartilagem

- RH01720





Osteotomo Summers Expansor



Osteotomo Summers Compactador



Cureta Óssea Bruns - 17 cm



Impactor de Enxerto - 14 cm



Parafuso de Bird

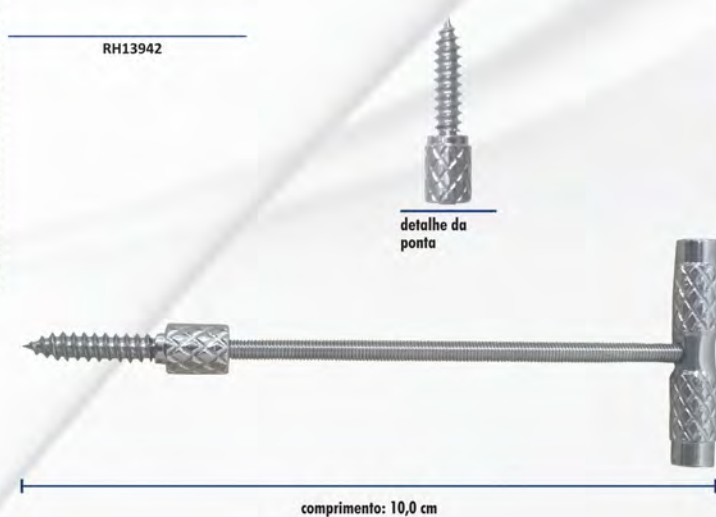

Triturado para Ossos





Kerrison - para Cima

Haste - 18 cm

02 MM	RH13861
03 MM	RH10916
04 MM	RH13862
05 MM	RH10917
06 MM	RH13863

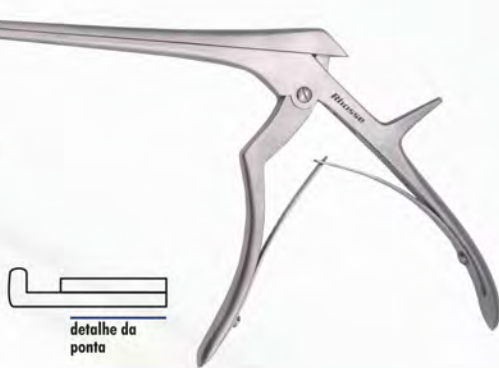

Kerrison - para Baixo

Haste - 18 cm

02 MM	RH13859
03 MM	RH10918
04 MM	RH13858
05 MM	RH10919
06 MM	RH13860

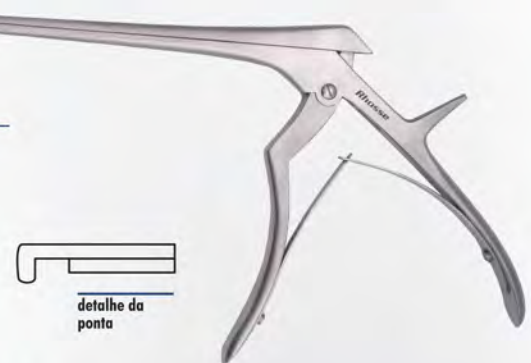

Kerrison 40° - para Cima

Haste - 18 cm

02 MM	RH13850
03 MM	RH10920
04 MM	RH13851
05 MM	RH10921
06 MM	RH13852

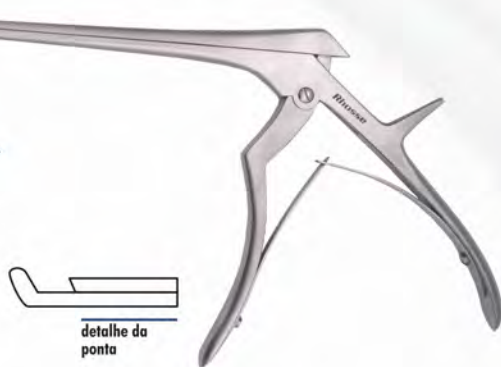

Kerrison 40° - para Baixo

Haste - 18 cm

02 MM	RH13853
03 MM	RH13854
04 MM	RH13855
05 MM	RH13856
06 MM	RH13857

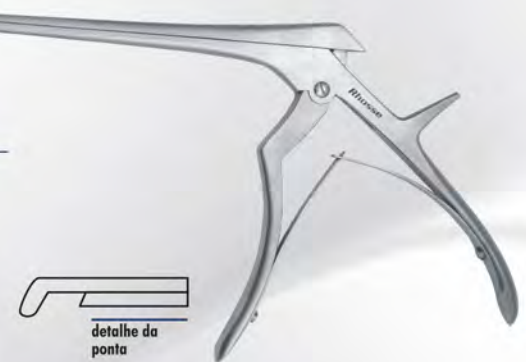

Hartman - Jacaré

Delicado

09 CM	RH10998
-------	---------

09 CM	RH10157
15 CM	RH10156



Back - Bite

ADULTO	RH13711
INFANTIL	RH13712
360°	RH13713



Sacabocado | Takahashi

Sacabocado

09 CM	RH11948
12 CM	RH11378



Takahashi

CURVA. 12 CM	RH10703
RETA. 12 CM	RH10506



Struycken

Angulada

ADULTO	RH13707
INFANTIL	RH13709



Reta

ADULTO	RH13708
INFANTIL	RH13710





Pinça Rowe - Par

DIREITA RH10487
ESQUERDA RH10486



Pinça Asch

RH01727



Pinça Walshan

RETA RH10519
ESQUERDA RH10523
DIREITA RH10524



Autocentrante

16 CM RH01686
19 CM RH01687
24 CM RH01688
26 CM RH10878
28 CM RH10527



Espanhola

16 CM RH01689
22 CM RH01690
24 CM RH11936
28 CM RH10543



Alicate Universal para Girar Fio com Corte

RH15301

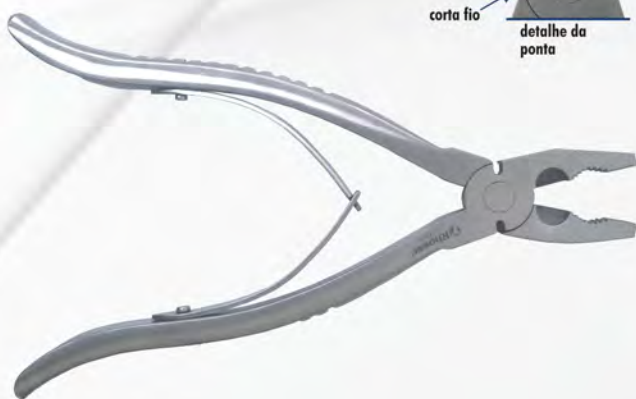

Alicate Universal para Girar Fio sem Corte

RH13940





Luer Curva - 16 cm
Alveolotomo

RH10375



Luer Reta - 16 cm
Alveolotomo

RH01861



Ruskin Curva - 19 cm
Dupla Articulação

RH13157



Ruskin Reta - 19 cm
Dupla Articulação

RH13158



Duck Bill - 23 cm. Dupla Articulação

05 MM RH12407
08 MM RH12298



Stille Luer Reta - 23 cm. Dupla Articulação

RH01866



Stille Luer Curva - 23 cm. Dupla Articulação

RH01867



Cizalha Ruskin Liston - 18 cm

RETA RH10735
CURVA RH10734



Cizalha Ruskin Liston - 19 cm

RETA RH14130
CURVA RH14150



Alicate Corte Frontal - 21 cm
Dupla Articulação com Vídea

RH01867





Cabo Nº 3

LISO RH01705
MILIMETRADO RH13074



Cabo Nº 3 - Redondo

RH10097



Cabo Nº 4

LISO RH01706
MILIMETRADO RH13075



Cabo Nº 4 - Redondo

RH01706



Cabo Duplo Nº 3 e Nº 4

RH13076



Cabo Nº 7

RH01707



detalhe da
ponta

Bisturi de Leão
para Implante Capilar

RH10369



detalhe da
ponta



Micro Lâmina

RH12670



Compassos | Compasses | Compás

Compasso

10 CM RH01717
20 CM RH01730



Compasso Castroviejo

RH10550



Régua

RH00000



Paquímetro

RH11771





Abridor de Boca Digmann - 4 Lâminas

3 LÂMINAS RH13076

Lâminas:
5 cm, 6 cm ou 7cm



Abridor de Boca Mc Ivor - 4 Lâminas e 2 Arcos

RH01716

Lâminas:
5 cm, 6 cm ou 7cm



Abre Boca Davis - 4 Lâminas

RH11491

Lâminas:
5 cm, 6 cm ou 7cm



Abre Boca Molt

RH12656



Abaixa Língua Bruenings

RH10307



Abridor de Boca Branemark

RH15651



Abridor de Boca Oringer

RH15028





Espátula Maleável

18,0x1,0CM	RH01713
18,0x1,5CM	RH01714
18,0x2,0CM	RH01715
18,0x2,5CM	RH12850
18,0x3,0CM	RH11076
30,0x2,0CM	RH10823
30,0x3,0CM	RH10825
30,0x4,0CM	RH10827
30,0x5,0CM	RH10829



Espátula para Pálpebra

18,0x0,7CM	RH13096
18,0x1,2CM	RH13097
18,0x2,0CM	RH13098
18,0x2,5CM	RH13099



Espéculo Killian - Nasal

Nº 1 - 3 CM	RH01469
Nº 2 - 5 CM	RH01470
Nº 3 - 7 CM	RH01471



Espéculo Hartman - Nasal

Nº 1	RH01469
Nº 2	RH01470
Nº 3	RH01471



Mille-Um

RH13943



detalhe das pontas

Descolador Colver para Amigdalá

SERRILHADO RH12659

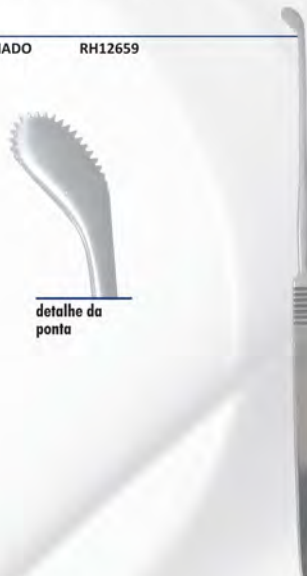

detalhe da ponta

Descolador Aspirador Colver para Amigdalá

RH11465



Frazier

20 CM. 1,0 MM	RH12285
20 CM. 1,5 MM	RH14506
20 CM. 2,0 MM	RH01790
20 CM. 2,5 MM	RH14507
20 CM. 3,0 MM	RH01789
20 CM. 4,0 MM	RH01788
20 CM. 5,0 MM	RH12780



detalhe da ponta

Aspirador Descolador

NASAL	RH11737
GIRATÓRIO	RH01608



detalhe da ponta

Poole - 22 cm

CURVO	RH11846
RETO	RH12799



detalhe da ponta

Fenestrado - 25 cm

COM CABO	RH14851
SEM CABO	RH13067



detalhe da ponta



Monopolar - Reta

14 CM	RH12231
16 CM	RH11811
18 CM	RH12824
20 CM	RH12218



Monopolar - Angulada

16 CM	RH11813
20 CM	RH14919
30 CM	RH15026



Monopolar - Angulada

14 CM	RH12803
16 CM	RH11812
18 CM	RH12893
20 CM	RH11816
25 CM	RH12947



Monopolar - Baioneta

Reta

17 CM	RH12225
20 CM	RH15015
22 CM	RH15324
25 CM	RH14918

Curva

20 CM	RH15014
22 CM	RH15013
25 CM	RH14917



Hemostática - Curva

12 CM	RH12219
14 CM	RH12220
16 CM	RH11810
18 CM	RH11809
20 CM	RH11808



Bipolar - Reta

Ponta Reta

10 CM	RH14753
12 CM	RH14758
14 CM	RH14763
16 CM	RH14768
18 CM	RH14774
20 CM	RH14780



Bipolar - Baioneta

Ponta Reta

10 CM	RH14682
12 CM	RH14686
14 CM	RH14691
16 CM	RH14696
18 CM	RH14702
20 CM	RH14708
22 CM	RH15025
25 CM	RH14715



Cabo Bipolar

3 METROS CPH100



Cabo Monopolar

3 METROS CPH102



Ponta Curva

16 CM	RH14797
18 CM	RH14774
20 CM	RH14807

Ponta Curva

14 CM	RH14720
16 CM	RH14725
18 CM	RH14730
20 CM	RH14735
25 CM	RH14740

Caneta Comando Pedal

CPD201



Caneta Comando Manual

CMD110



Eletrodos

TIPO AGULHA

TIPO ALÇA

TIPO BOLA

TIPO FACA





Farabeuf - Par

- 0,7 CM x 10,0 CM RH10512
- 1,0 CM x 12,0 CM RH01654
- 1,3 CM x 12,5 CM RH01663
- 1,5 CM x 15,0 CM RH01678
- 2,0 CM x 18,0 CM RH12370



Farabeuf para Mama - Par

- 2,0 CM x 18,0 CM RH01679



Farabeuf para Mama - Revestido

- 2,0 CM x 18,0 CM RH15119



Daher - Par

- RH11440



Aufricht

- RH01650



com Cabo

- RH01650



Universal com Cabo para Mento

- RH15481



Converse

- RH01652



Wieder

- RH12755



Mead

- RH10731



Sen Müller

- AGUDO RH01655
- ROMBO RH11584



Love Desmarres

- 04 MM RH10008
- 12 MM RH14004
- 15 MM RH13120
- 20 MM RH15042
- 25 MM RH15342
- 30 MM RH15343



Love Desmarres - Revestido

- 04 MM RH15367
- 12 MM RH14004
- 15 MM RH15368
- 20 MM RH15122





Langenbeck - Mini Duplo

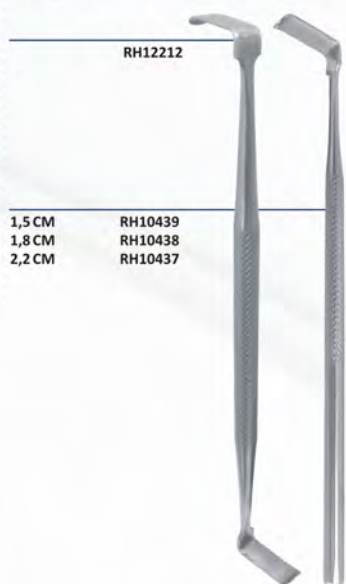

RH12212

1,5 CM RH10439
1,8 CM RH10438
2,2 CM RH10437

Langenbeck



35 x 10 MM RH10781
35 x 15 MM RH10782
60 x 10 MM RH10541
60 x 15 MM RH01541
80 x 10 MM RH13705

Langenbeck para Ramo



35 x 10 MM RH14010
60 x 10 MM RH10549
60 x 15 MM RH13122

Langenbeck Reverso



35 x 10 MM RH12916
35 x 15 MM RH13706
60 x 10 MM RH10540
60 x 15 MM RH13123

Minnesota

com Aspirador

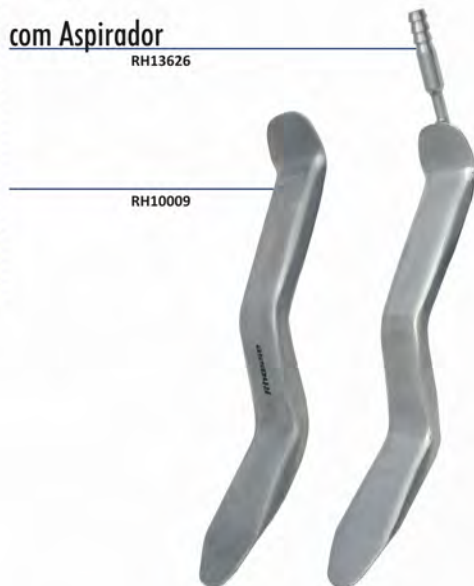

RH13626

RH10009

Separador Sagital - Par



RH12758

Separador Sagital Smith



RH12758

Obwegeser

Modificado

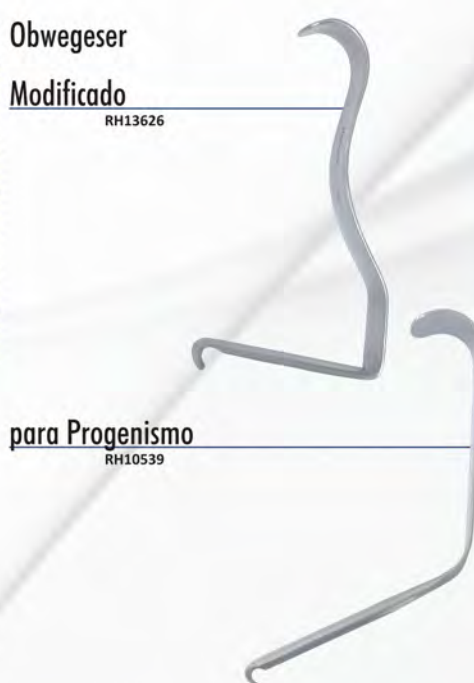

RH13626

para Progenismo

RH10539

Lavassier

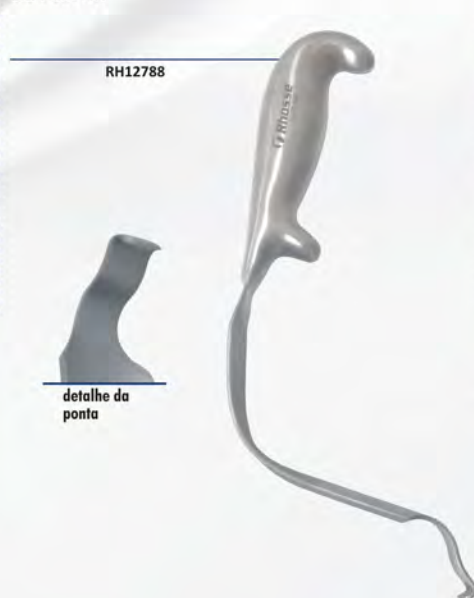

RH12788

detalhe da ponta

Bauer - Par

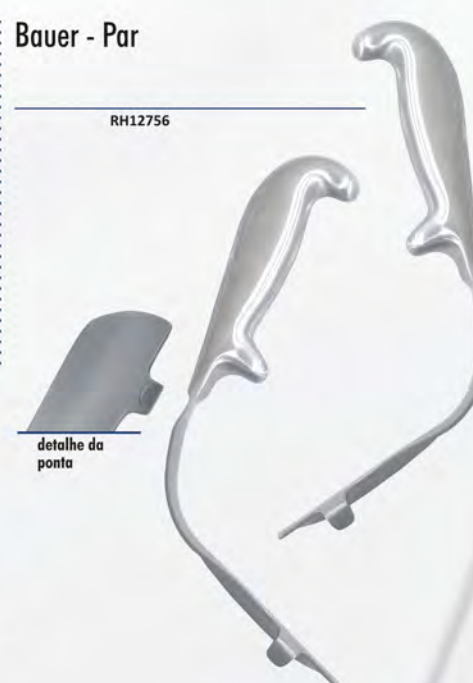

RH12756

detalhe da ponta



Tentacânula

RH01719



Afiador de Tesouras

RH10008



Seringa de Carpule

RH01732



Estojos e Bandejas | Cases and Trays | Casos y Bandejas

Estojos de Inox Perfurados

12,0 x 5,0 x 2,0 CM	10119
14,0 x 8,0 x 2,0 CM	13986
18,0 x 8,0 x 3,0 CM	10129
18,0 x 8,0 x 5,0 CM	10131
20,0 x 10,0 x 3,0 CM	10133
20,0 x 10,0 x 5,0 CM	10135
26,0 x 12,0 x 6,0 CM	10144
28,0 x 14,0 x 6,0 CM	10148
32,0 x 16,0 x 8,0 CM	10156
36,0 x 22,0 x 9,0 CM	3167
42,0 x 18,0 x 9,0 CM	3175



Estojos de Policarbonato

18,0 x 8,0 x 1,5 CM	2801
25,0 x 15,0 x 1,5 CM	2803

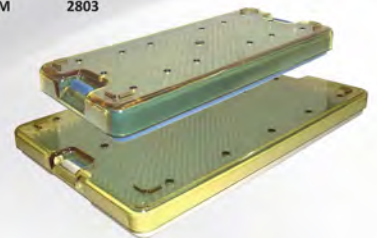

Cubas

8,0 x 4,0 CM - 150 ML	0000
9,0 x 5,0 CM - 200 ML	0000
10,0 x 5,0 CM - 300 ML	0000
13,0 x 6,0 CM - 500 ML	0000



Cuba Rim

26,0 x 12,0 CM	0000
----------------	------



Bandejas de Inox

18,0 x 8,0 x 2,3 CM	9328
21,0 x 11,0 x 3,5 CM	9335
22,0 x 12,0 x 1,5 CM	9331
22,0 x 17,0 x 1,5 CM	9332

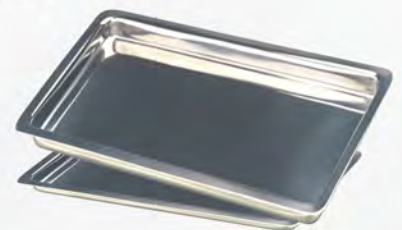

Bacia Inox

32 CM - 3.100 ML	1390
35 CM - 4.700 ML	1391
41 CM - 6.300 ML	1392



Potes Dappen Inox

PEQUENO	RH13756
MÉDIO	RH15442
GRANDE	RH15443



Potes Dappen de Polimero

AUTOCLAVÁVEL	RH13909
--------------	---------





Fonte de Luz LED - Rhosse

RH15003

20.000 HORAS DE VIDA ÚTIL PARA O LED
SUPER LEVE! MENOS DE 2 KG
LÂMPADA LED DE 9 WATTS
BIVOLT AUTOMÁTICO
MICROPROCESSADA



Fonte de Luz XENON - Rhosse

RH15052

SUPER LEVE E COMPACTA!
MICROPROCESSADA
BIVOLT AUTOMÁTICO



Cabo de Fibra Óptica

Autoclavável

2,0 METROS RH13949
2,5 METROS RH15016



2,0 METROS RH12857



Afastador Universal

10 CM RH13939
14 CM RH13903
18 CM RH13948

com Aspirador

10 CM RH11823
14 CM RH11824
18 CM RH15082



Afastador Universal 100% Visão

10 CM RH15384
14 CM RH15385
18 CM RH15386



detalhe do afastador

Afastador Universal com Cabo

100 x 25 MM RH13315
100 x 30 MM RH13316
120 x 25 MM RH13317
120 x 30 MM RH13318
140 x 25 MM RH13319
140 x 30 MM RH13320

com Aspirador

120 x 25 MM RH15083



Afastador Aufricht

RH13904



Afastador Wieder

RH12919

com Aspirador

RH13188



Afastador Minnesota

RH13626



Espéculo Nasal

Nº 1. 3 CM RH14630
Nº 2. 5 CM RH14025
Nº 3. 7 CM RH14631



Frazier

2 MM RH13717
4 MM RH13743





Pinça Kocher Modificada - 90° Graus

RH13690



Afastador Lavassier

RH13742



Afastador Bauer

RH13741



Langenbeck

60 x 15 MM RH15080
60 x 10 MM RH13716



Langenbeck Reverso

60 x 10 MM RH13740



Langenbeck para Ramo

60 x 10 MM RH13739



Tipo Gota

13 CM RH14068
16 CM RH14897



Adaptadores para Afastadores e Cabos de Fibra Óptica Compatibilidade Universal

Cabos de Fibra Óptica



WOLF DYONICS STORZ EDLO OLYMPUS REICHEMBACH RHOSSE STORZ RHOSSE

Afastadores



RHOSSE ENCAIXE RHOSSE EDLO RHOSSE STORZ STORZ ÓPTICA STORZ



Caixa para Cirurgia Ortognática

Código	Un.	Descrição
RH10541	02	Afastador Langenbeck 60x10mm
RH10781	02	Afastador Langenbeck 42x10mm
RH10540	02	Afastador Langenbeck Reverso 60x10mm
RH12916	02	Afastador Langenbeck Reverso 42x10mm
RH10549	01	Afastador Langenbeck para Ramo 60x10mm
RH10009	01	Afastador Minessota
RH10539	01	Afastador Obwegeser para Progenismo
RH01409	01	Cinzel Curvo 08mm
RH01403	01	Cinzel Reto 08mm
RH12650	01	Cinzel Sversut
RH13016	01	Cinzel de Wagner Curvo 06mm
RH13017	01	Cinzel de Wagner Reto 06mm
RH01788	01	Aspirador Angulado 4mm
RH01430	01	Raspa Dorso Sperli N. 1
RH10375	01	Goiva Luer 16cm Curva
RH01450	01	Martelo de 250gr
RH12755	01	Afastador Wieder (Coração)
RH01203	01	Porta Agulha Mayo Hegar Com Videa 14cm
RH01205	01	Porta Agulha Mayo Hegar Com Videa 18cm
RH10698	02	Pinça Dietrich 18cm
RH01104	01	Pinça Adson Serrilhada 12cm
RH01101	01	Pinça Adson Dente de Rato 12cm
RH01064	01	Tesoura Corte Fio de Aço Angulada 11cm
RH01226	02	Porta Agulha Fio de Aço 16cm
RH01027	01	Tesoura Metzemaum Curva 14cm
RH01026	01	Tesoura Metzemaum Reta 14cm
RH01060	01	Tesoura Joseph Reta 14cm
RH01059	01	Tesoura Joseph Curva 14cm
RH01705	01	Cabo de Bisturi N. 3
RH01715	01	Espatula Maleavel 18x2cm
RH13265	01	Separador de Cavidade de Smith
RH12758	01	Separador Sagital - Par
RH12756	01	Afastador de Bauer - Par
RH12788	01	Afastador Lavassier
RH10048	02	Descolador Molth
RH01601	01	Descolador Freer Duplo
RH01321	01	Gancho de Malar
RH10550	01	Compasso Castroviejo para Microcirurgia
RH10555	01	Paquimetro
RH11560	01	Descolador de Sverzut
RH13689	01	Pinça Kocher Angulada 20cm 90°
RH13691	01	Descolador Freer Modificado
3156	01	Estojo de Inox 32x16x08cm

Caixa para Cirurgia de Trauma

Código	Un.	Descrição
RH10487	01	Pinça Rowe direita para Maxilar
RH10486	01	Pinça Rowe esquerda para Maxilar
RH10524	01	Pinça Walshan direita 23cm para septo
RH10523	01	Pinça Walshan esquerda 23cm para septo
RH10519	01	Pinça Walshan reta 23cm para septo
RH01727	01	Pinça Asch para septo
RH10387	01	Espéculo nasal n°2 - 5cm com fibra óptica
RH10463	01	Pinça de redução com cremalheira 13cm
RH01659	01	Afastador Love Desmarres 12mm
RH10437	01	Afastador Mini- Langenbeck
RH01302	02	Gancho Gilles Forte
RH01004	01	Tesoura Iris Curva Ponta romba 11cm
RH01704	01	Cureta óssea n°0
RH01606	01	Descolador de Periosteio 7mm
3156	01	Estojo de Inox 32x16x08cm

Observação Importante:

A Caixa de Trauma é composta por todos os itens da Caixa de Ortognática acrescidos pelos itens acima.

Caixa Especial com Fibra Óptica

Código	Un.	Descrição
RH15030	01	Fonte de Luz LED
RH13949	01	Cabo de Fibra Óptica Autoclavável 2,0 metros
RH12919	01	Afastador Wieder com Fibra Óptica
RH13716	01	Afastador Langenbeck com Fibra Óptica 60x10mm
RH13704	01	Afastador Minessota com Fibra Óptica
RH13739	01	Afastador Langenbeck Ramo com Fibra Óptica
RH13740	01	Afastador Langenbeck Reverso com Fibra Óptica
RH13741	01	Afastador de Bauer com Fibra Óptica - Par
RH13742	01	Afastador Lavassier com Fibra Óptica
RH13743	01	Aspirador Frazier Angulado 4mm com Fibra Óptica



Central de Atendimento

Rhosse
Instrumentos e Equipamentos Cirúrgicos

Rua Sebastião Martins Viana, 495
Recreio Anhanguera. Ribeirão Preto - SP
CEP: 14097-020. Fone: 16 3965 9200
SAC: 0800 7070 667

Para comprar ligue:

0800 7070 667



encontre-nos nas redes sociais:



facebook.com/rhosse.ie.cirurgicos



twitter.com/rhosse_



youtube.com/rhosseiecirurgicos



acesse

www.rhosse.com.br

agora com a

maior loja virtual

de instrumentos cirúrgicos específicos para sua área. Confira!

Catálogo de Cirurgia Bucomaxilofacial



Registrado nos órgãos:

Agência Nacional
de Vigilância Sanitária



Contato: **0800 7070 667**

www.rhosse.com.br

Rua Sebastião Martins Viana, 495 - Recreio Anhanguera. Ribeirão Preto. SP - CEP: 14097-020